

Stallion Bariatric Script

Bariatric Fixed Frame Adjustable Wheelchair

90100B



To Order Fill in the frame dimensions and features required. For variations describe in detail on a separate page. If you have any further questions contact us at the address at the bottom of the page.

SEND FORM
If online, click here to send via e-mail

Date _____

Name _____

Address _____

Phone _____

Fax / Cell _____

Email _____

Disability _____

Weight _____

Height _____

Delivery details _____

Therapist details _____

Required by _____

TRIAL CHAIR REF: _____

Shoe Size _____

T-Shirt Size _____

MEASUREMENTS (Refer to diagram)

Max User Weight 250kg

Materials Aluminium

A Seat width	22" <input type="checkbox"/> 24" <input type="checkbox"/> 26" <input type="checkbox"/>	D Back angle°	_____	I Camber (0°-5°)	_____
A Custom seat width	AD10100	E Seat to footplate	_____	J Hanger Angle	<input type="checkbox"/> 70° <input type="checkbox"/> 80° <input type="checkbox"/> 90°
B Seat depth	18" <input type="checkbox"/> 20" <input type="checkbox"/> 22" <input type="checkbox"/> 24" <input type="checkbox"/>	F Seat to floor - front	_____	Back Style	<input type="checkbox"/> Folding Back <input type="checkbox"/> Fixed Back
B Custom seat depth	AD10100	G Seat to floor - rear	_____		
C Back height	_____	H Balance Point	_____		

ADDITIONAL NOTES

(you can type here)

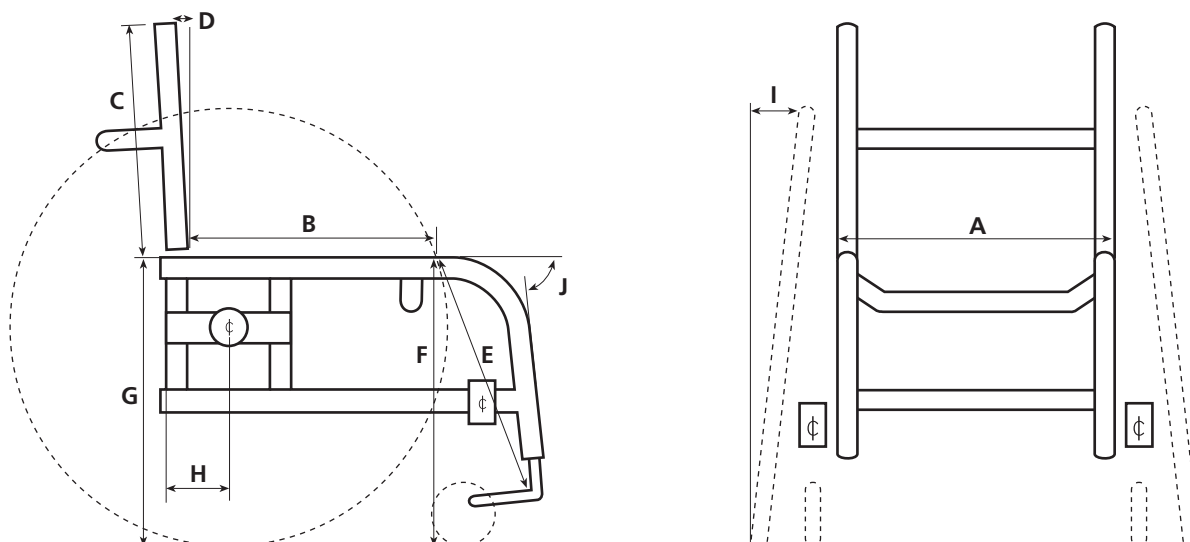

Stallion Bariatric Script Form

Bariatric Fixed Frame Adjustable Wheelchair



Name _____

HANGER TYPE

Swing Away



Drop In Swing Away



FOOT-PLATE WIDTH

Width for V style foot-plates

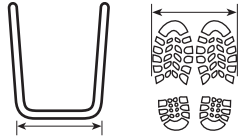

If measuring across feet you must add 2" (50mm)

SWING AWAY FOOTREST

Straight Swing Away

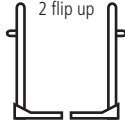

V Swing Away

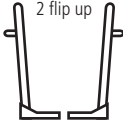

Straight Swing Away

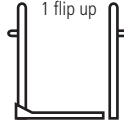

V Swing Away

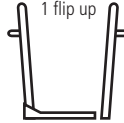

Straight Hangers

2 piece, flip up angle adjustable alloy foot-plates (std)

V Hangers

1 piece, flip up angle adjustable alloy foot-plates opens to the left **AD11450**

1 piece, flip up angle adjustable alloy foot-plates opens to the right **AD11450**

DROP IN SWING AWAY FOOTREST

Straight Fixed

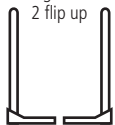

V Fixed

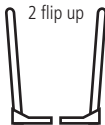

Straight Hangers

2 piece, flip up angle adjustable alloy foot-plates (std)

V Hangers

Angle adjustable foot-plate **AD11520**

ELEVATING LEG REST Made for the Swing Away front only

Left **AD11610**

Right **AD11610**

Both **AD11600**

STUMP SUPPORT Made for the Swing Away fronts only

Left **AD11650**

Fixed

Right **AD11650**

Removable

Both **AD11651**

Name _____

CASTORS

- 5" solid alloy (std) 6" solid alloy (std) 8" floater **AD11761**
 5" x 1.5" alloy **AD11740** 6" x 1.5" alloy **AD11742**
 5" wide soft roll **AD11810** 6" wide soft roll **AD11820**

FORKS

- Standard forks (std) Other _____

PUSH HANDLES

- Nil Removable on grab bar **AD14100** In back canes **AD14140** Stroller D **AD14200**
 Dual clamp adj height **AD14120** Foldable in back canes **AD14160** Stroller handles removable **AD14240**

BRAKES

- Nil Pull to lock **AD14510** Brake extensions **AD14550** Foot brake **AD14660**
 Push to lock (std) Hill climbers **AD14530**
 Push to lock (long handle) **AD14551** Reverse handles

ANTI-TIPS

- Nil Stainless steel with plastic wheels (std) Stainless steel adjustable anti tips **AD15010**
 Kick tube **AD15040** Stainless steel with rollerblades **AD15030**

ARMRESTS

- Nil
 T adjustable height with desk pad armrest **AD15260** T adjustable height with full length pad armrest **AD15261**
 T adjustable height desk pad armrest with ABS skirt guard **AD15280** T adjustable height full pad armrest with ABS skirt guard **AD15281**

UPHOLSTERY

- Sling (std) To fit solid back _____ Cushion 2" **AD16202** Bag on back of chair **AD16680**
 No back upholstery _____ Cushion 3" **AD16203** Bag on front left hanger **AD16620**
 Tension adjustable back (std) Cushion 1" **AD16201** Bag under chair **AD16600** Bag on front right hanger **AD16620**

SKIRT GUARDS

- Nil ABS drop in **AD16110** Alloy with fixed back **AD16130** Carbon Fibre folding back **AD16160**
 Fabric skirt guards **AD16100** ABS fabric covered **AD16120** Alloy with folding back **AD16140**

STRAPS / BELTS, GUARDS, GLOVES

- Leg strap (std) Impact guards hangers **AD16400** Seat belt with plastic buckle **AD16500**
 Heel loops (std) Impact guards back bars **AD16420** Seat belt (childs) with metal car type buckle **AD16520**
 Castor pivot covers **AD16410** Seat belt (adult) with metal car type buckle **AD16522**
 Gloves _____ Fabric footplate cover **AD11510** Hip strap 4 point belt **AD16540**
(size & style)

TRAY

- Slides over armrests (reinforced) **AD17001**

Name _____

WHEELS

24"

Bariatric Spoked Wheels (std)

TYRES

24"

- 24" x 1-3/8" Tread (std)
- 24" x 1-3/8" Solid (std)
- 24" x 1-3/8" Kenda HP Tread **AD13710**
- 24" x 1-3/8" Primo V-Trak Knobbly **AD13715**

AXLES

Quick release axles (std) Quad release **AD12500**

SPOKE GUARDS

Clear polycarb **AD13900** Black ABS **AD13901**

PUSHRIMS

- Anodised (std) Surge **AD13864** Natural Fit Lite with thumbguard **AD13860**
- Rubber Coated (black) **AD13850** Max Greppe **AD13870** Natural Fit Lite without thumbguard **AD13860**
- Vinyl **AD13830** Capstan No. of projections: _____ Angle: _____ Length: _____

PUSHRIMS - POSITION

Standard In close Onto rim

Stallion Bariatric Script Form

Bariatric Fixed Frame Adjustable Wheelchair

Name _____

ATTENTION

THIS IS A GUIDE TO COLOURS ONLY, how colours appear on your monitor or when printed out may vary.

Talk to us if you want your Titanium frame coloured or polished. *Colour availability is subject to change without notice.*

STANDARD & ENABLE CLIENT COLOURS

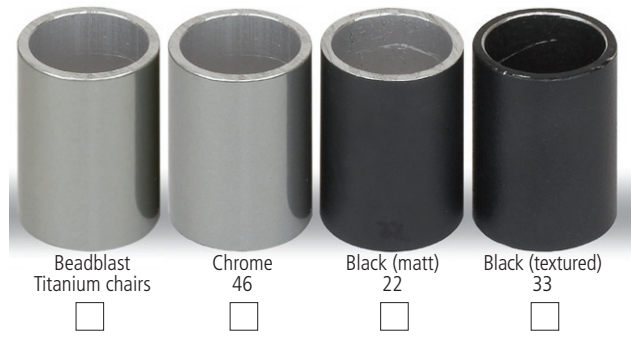

GLASS COLOURS



CANDY COLOURS



CANDY COLOURS (SPECIAL)



FLUORESCENT COLOURS

